

# RIKEN PORTABLE HC/O<sub>2</sub> DETECTOR MODEL R X - 4 1 5

## OPERATION MANUAL

(PT0-028)

### Precaution in operation

- After reading this manual well, start to operate this instrument.
- Keep this manual where to carry out easily
- When take out this manual by use of construction work, be sure to put it where it was.
- Do not use this instrument for no other than given purpose.
- When operate this instrument without using this manual or repair it by use of no other parts than the genuine one, the safety and quality of products could not be guaranteed. When any accident should take place by those irregular method, we cannot assume the responsibility for it.

## RIKEN KEIKI Co.,Ltd.

2-7-6 Azusawa, Itabashi-ku, Tokyo, 174-8744, Japan

Phone : +81-3-3966-1113

Fax : +81-3-3558-9110

E-mail : [intdept@rikenkeiki.co.jp](mailto:intdept@rikenkeiki.co.jp)

Web site : <http://www.rikenkeiki.co.jp/english/>

## **In the beginning**

It is of our great pleasure to purchase Riken portable HC/O<sub>2</sub> gas indicator model RX-415 this time. This instrument is an explosion-proof type portable gas indicator which is designed to measure the presence of crude vapors in an inert gas or in air such as HC gas, vapors and methane gas and O<sub>2</sub>.

This instruction manual is a guide book for operation of Riken portable HC/O<sub>2</sub> gas indicator model RX-415. It is kindly requested to read and understand this content by experienced users as well as beginners. The following headline shall be shown to carry out the safety and effective work in this instruction manual.

Model RX-415 is approved by certificate number:  
Baseefa 05ATEX0101

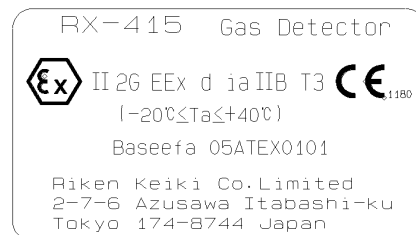

### **Danger**

This means that it gives the serious harm to the human life, body or material directly such as touching high voltage.

### **Warning**

This means that it gives the serious harm to the human body or material if do not perform the operation according to the instruction manual.

### **Caution**

This means that it gives the slight harm to the human body or material if do not perform the operation according to the instruction manual.

### **\* Note**

This means the advice in the operation.

Model RX-415 consists of two type according to the kind of gases below ;

For HC gas use : Model RX-415 (TYPE HC)  
HC : 0-100%LEL/0-100vol%  
O<sub>2</sub> : 0-25vol%  
For CH<sub>4</sub> gas use : Model RX-415 (TYPE CH<sub>4</sub>)  
CH<sub>4</sub> : 0-100%LEL/0-100vol%  
O<sub>2</sub> : 0-25vol%

	Page
1 . Caution in operation (for your safety) . . . . .	3
2 . Name of each part . . . . .	4
3 . Operation	
3 - 1 . Check item before operation . . . . .	6
3 - 2 . Preparation . . . . .	6
3 - 3 . Start-up procedure . . . . .	8
3 - 4 . Check of the flowmonitor . . . . .	9
3 - 5 . Zero adjustment . . . . .	9
3 - 6 . Measurement . . . . .	10
3 - 7 . Stop of pump operation . . . . .	12
3 - 8 . Measurement completion . . . . .	13
4 . Alarm function	
4 - 1 . Kind of alarm and alarm function . . . . .	14
4 - 2 . Countermeasure at alarm . . . . .	15
5 . Maintenance check	
5 - 1 . Battery replacement . . . . .	16
5 - 2 . Gas calibration . . . . .	17
5 - 3 . Filter replacement . . . . .	22
5 - 4 . O2 sensor replacement . . . . .	23
5 - 5 . Daily check and regular maintenance check . . . . .	24
5 - 6 . Replacement of parts . . . . .	24
5 - 7 . Storage and disposal when the instrument is not used for a long time . . . . .	24
6 . Scrap of instrument . . . . .	25
7 . Troubleshooting . . . . .	26
8 . Definition of words . . . . .	27
9 . Specifications	
9 - 1 . Specifications . . . . .	28
9 - 2 . Accessories (Common for HC and CH4) . . . . .	30
1 0 . Detection principle	
1 0 - 1 . NDIR method (Non-Dispersive Infrared) . . . . .	31
1 0 - 2 . GALVANIC CELL method . . . . .	31

---

---

## 1. Caution in operation (for your safety)

---

---

Keep the following items below to maintain the function of instrument and for safety.

### Warning

- Do not modify or alter the circuit or structure etc.  
After modifying and altering the instrument, the function can not be maintained any longer.
- As this is explosion-proof type instrument, make the battery replacement at non-hazardous-zone. The replacement at hazardous zone will be beyond the scope of explosion-proof concept.
- As this is explosion-proof type instrument, be sure to operate with carrying case on.

### Warning

- Sensor life can be excessively reduced under the condition where acid gas and solvent gas are existing. In this case, make measurement as quickly as possible.  
After measurement, make sensor cleaning by introducing fresh air.

### Caution

- Do not fall or crush it.  
As this is a fine instrument, the function may not be maintained if high impulse or shock is given.
- Do not splash water directly.  
As this is not drip-proof structure, it will be a cause for trouble if water is splashed directly.
- Do not give the electrical noise during operation by strong walkie-talkie wave etc.  
When give the electrical noise to the instrument, it will be a cause to damage the instrument.
- When the temperature in air is changed drastically, it may affect the reading of the instrument.
- When it is in dew or condensed, the normal measurement can not be carried out.
- For internal filter and filter tube, be sure to operate it with them on by all means.

### \* Note

- When measure the gas contains water, suck it after removing water.
- When measure high temperature gas, make measurement after the instrument accustom itself to its temperature.

---

---

## 2. Name of each part

---

---

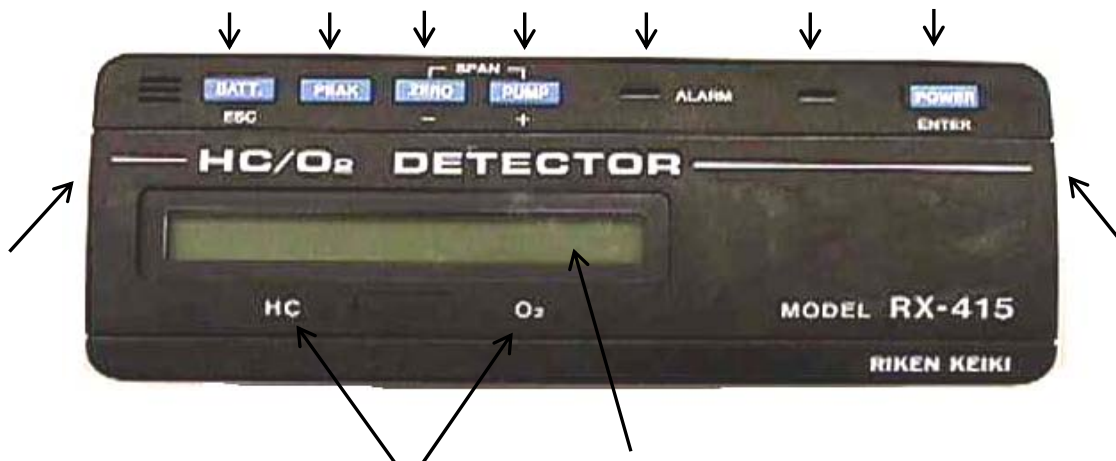

### Power/Enter switch

This is used for the confirmation of power ON, OFF/input.

### PUMP/(+) switch

This is used for pump Switch ON/OFF and to increase the input value.

### ZERO/(-) switch

This is used for zero adjustment and decrease the input value.

### PEAK switch

This is used when desired to show the peak value.

### BATT/ESC switch

This is used when desired to show the battery voltage and cancel the input.

### Gas outlet

This is the outlet to exhaust sample gas out.

### Calibration gas name plate

This shows the calibration gas name.

### Display unit (LCD display with back light)

This displays gas concentration.

### Alarm lamp

This flickers and lights on at trouble alarm time.

### Photo sensor window

This is for automatic back-lights of display unit by detecting that it gets dark around.

### Gas inlet

This is a measuring gas inlet.



Carrying case

Junction tube (20cm)

Gas sampling probe + Sampling tube (1m)

Filter tube with the flowmonitor

## 3. Operation

### 3 - 1 . Check item before operation

Instrument :

- Check that there is no damage on the display unit.

Filter tube with the flowmonitor :

- Check the dirt of cotton and when it gets dirty, replace the cotton with new one. (See 5-3)
- When the water drops are deposited, drain it out.
- Check that there is no crack or damage.
- Check that there is no looseness on the nipple mounting.

Gas sampling tube :

- Check that there is no break or twist of it.

### 3 - 2 . Preparation

- (1) Mount the battery into the instrument. (See 5-1)
- (2) Put the instrument into the carrying case.
- (3) Connect the junction tube, the filter tube with the flowmonitor and the gas sampling tube with the gas inlet of the instrument in turn.



As there are several types of head tubes for the instrument, use them according to each environment.

Standard specification	Spiral sampling tube 1m + Gas sampling tube
Optional specification	Gas sampling tube 30m Black (with stick probe or float probe)
	Gas sampling tube 20m Black (with stick probe or float probe)
	Gas sampling tube 10m Black (with stick probe or float probe)
	Gas sampling tube 29m Orange + Junction tube 1m Orange (with stick probe or float probe)

- Connection between gas sampling junction tube and model RX-415.  
By holding knurling part with fingers, pull it to the arrow mark.  
Plug in to the arrow mark with its condition. Release the fingers holding the knurling part and press in. Then, locked after ticking sound.

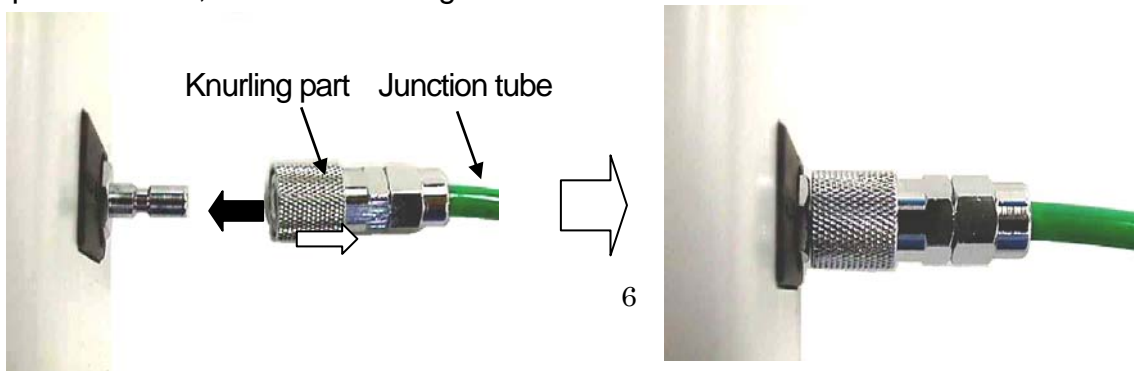

- Connection between gas sampling junction tube and sampling tube (Optional specification).  
By holding the socket of gas sampling junction tube and the plug of sampling tube by fingers and plug in to the arrow mark until it gets a ticking sound.

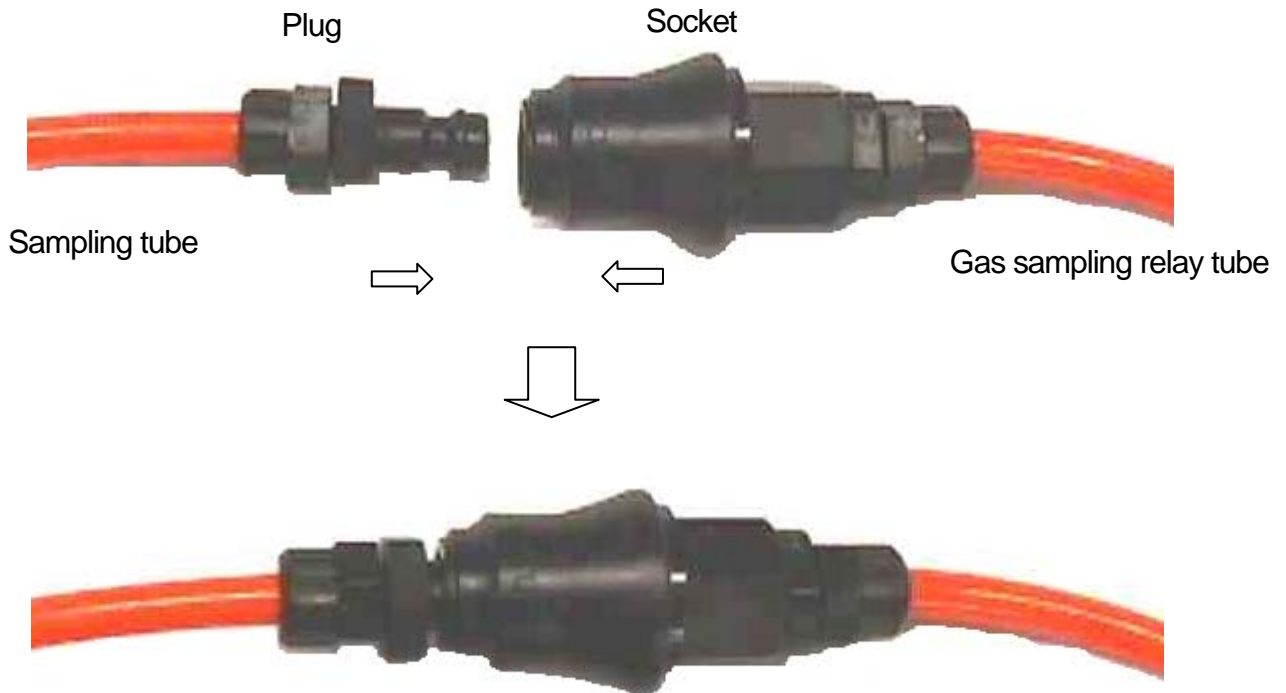

### **⚠ Warning**

- As this is used in dangerous zone, be sure to use it with carrying case.

### **⚠ Caution**

- Be sure to plug in the gas sampling tube and junction tube.  
If not surely connected, the accurate measurement cannot be carried out.
- Be sure to mount the filter tube with the flowmonitor.  
If measure without filter, it will be a cause of trouble by sucking dust, water and oil etc.



### 3 - 3 . Start-up procedure

Hold pressing power switch for 5 seconds and the power will turn on. Via battery check, filter probe connection check and sensor connection check, the gas detection will start. The sequence performance until the gas detection starts is as follows :

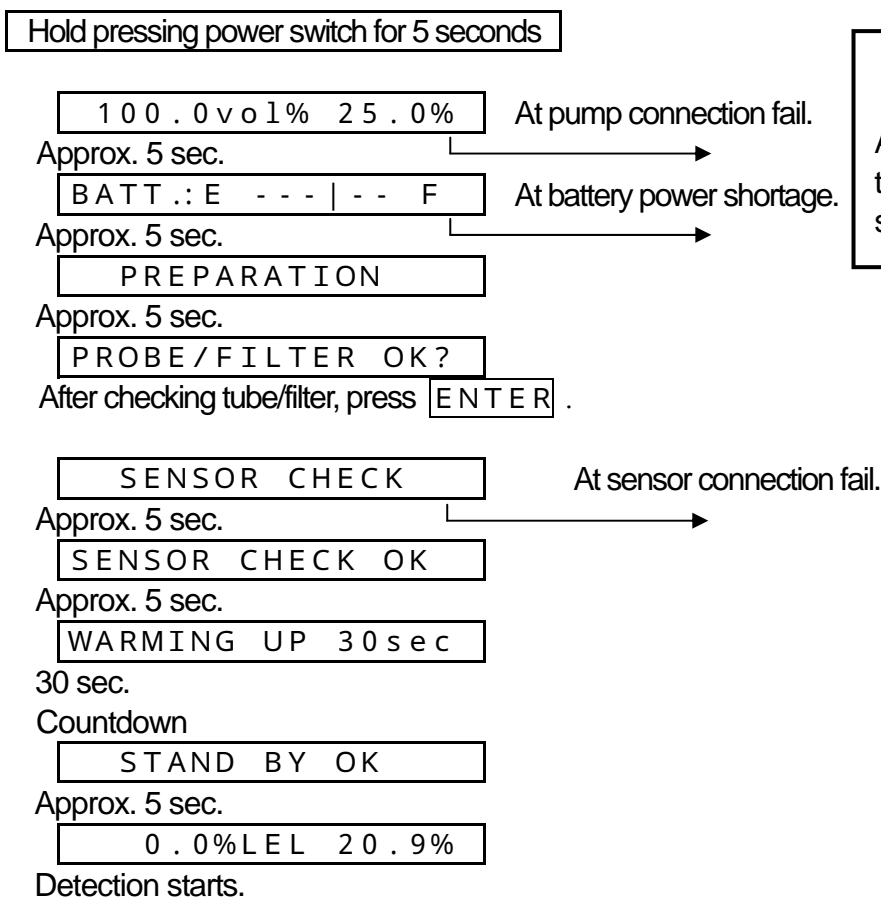

**\* Note**  
At power on, check that the buzzer and pump sound.

Display, performance at pump connection failure. (See 3.)

**FAIL PUMP** (Lamp : Light-on, Buzzer : Continuous)

Display, performance at power voltage shortage. (See 3. and 5-1)

**REPLACE BATTERY** (Lamp : Light-on, Buzzer : Continuous)

Display, performance at sensor connection failure. (See 3.)

In case of HC sensor connection failure

**FAIL SENSOR HC** (Lamp : Light-on, Buzzer : Continuous)

In case of O2 sensor connection failure

**FAIL SENSOR O2** (Lamp : Light-on, Buzzer : Continuous)

In case of HC sensor/O2 sensor connection failure

**FAIL SENSOR** (Lamp : Light-on, Buzzer : Continuous)

3 - 4 . Check of the flowmonitor

When turn on power, the pump starts working. Check that it works properly by the flowmonitor (float) of filter tube with the flowmonitor.

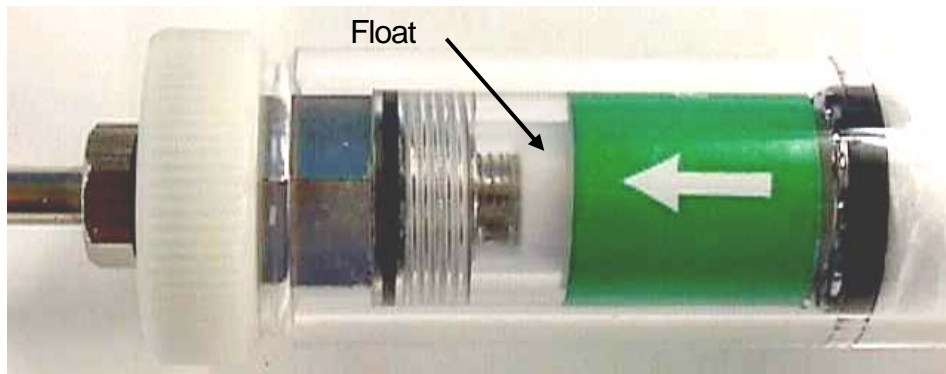

When sucking properly (Can see the float)

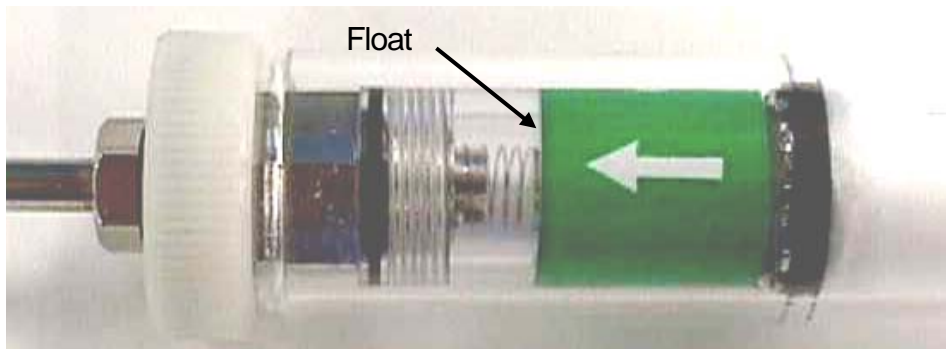

Not sucking properly (Cannot see the float)

3 - 5 . Zero adjustment

Make zero adjustment by removing the gas sampling tube. After the detection starts, see the flowmonitor and check that the air is sucked properly. Then, check that the reading gets stable and make zero adjustment by sucking the fresh air into instrument.

The operation procedure is shown below.

0 . 0% L E L 2 0 . 9% ( Gas display )

H O L D   Z E R O   K E Y   Hold pressing Z E R O for approx. 3 sec.

A P P L Y   F R E S H   A I R   After checking that fresh air is sucked into instrument and then, press E N T E R switch.

A D J U S T I N G   Z E R O

Approx. 5 sec.

Z E R O   S E T   O K

Approx. 5 sec.

0 . 0% L E L 2 0 . 9% ( Gas display )

Zero calibration failure

Display, performance at zero calibration failure (See 3.)

In case of HC zero cal. failure

FAIL ZERO HC /

In case of O2 zero cal. failure

FAIL ZERO /O2

In case of HC/O2 zero cal. failure

FAIL ZERO HC/O2

### Caution

When make zero adjustment, do it after having fresh air sucked into instrument for over 1 minute.

If zero point is adjusted under presence of gas, the accurate detection can not be carried out, and oxygen deficiency accident may be occurred.

### \* Note

- When desired to cancel the pre-operation, press **ESC** switch but after confirmed, it can not be cancelled.

## 3 - 6 . Measurement

(1) Move the sampling tube end towards measuring point and draw gas.

-Take care not to bend and twist sampling tube.

-Check that it is drawn properly by the flowmonitor.

-Set the sampling tube end at the point of measurement, take into account the length of sampling tube, and read out the gas concentration after getting stable of gas reading.

### Danger

- There may be the oxygen deficiency at gas outlet point due to the inert gas.  
Do not breathe at all.
- There may be the exhaust of high density gas (Above LEL).  
Do not approach the fire to it.

## Warning

- When the temperature is drastically changed at next detection point, in order to make accurate measurement, wait until the instrument accustom itself to its temperature (approx 10 min.). Then, start measurement after air calibration.

## Warning

- When measure O<sub>2</sub> in inert gas, confirm that CO<sub>2</sub> density of sucked air is under 15%. If over 15% of CO<sub>2</sub> is introduced, that may decrease the sensor life.  
(See 8. Caution in operation)

## Caution

- Do not let water or oil sucked into instrument. If it should be sucked, the pump or sensor shall be failed.
- When measure, check the running sound of pump and the flowmonitors.  
It cannot be measured at stop of pump operation.
- When the measuring gas is except calibration gas, the display reading will show at slightly high or slightly low side position.
- Do not block the gas outlet because the display reading may show the slightly high position.

## \* Note

- When suck high density gas above LEL, the hang-up phenomenon takes place from the adsorption of it to the gas sampling tube and filter tube.  
When use the range of vol%, use it as it is.  
  
When make zero adjustment, remove the gas sampling tube and let fresh air sucked into instrument.  
When measure by %LEL range, clean the gas sampling tube by air and try to measure after the display reading goes down zero.

### (2) Battery voltage

By pressing BATT switch while in operation, the battery voltage at present can be confirmed. The battery voltage will return to the gas concentration reading if there is no input of this switch "ON" for 20 seconds.

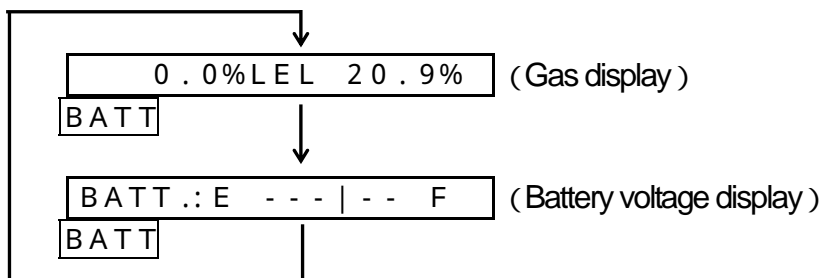

### (3) Read-out of peak value

When press PEAK switch in operation, this shows the peak value (Max point of reading for HC, Minimum point of reading for O<sub>2</sub>) from the power switch "ON" up to now.

Then press PEAK switch again, the peak model is cancelled and returns to the measurement mode. Then if there is no input of peak for about 20 seconds, this shall return to the measurement mode. When hold pressing ESC switch for 3 seconds in the peak display, the peak value will be cleared.

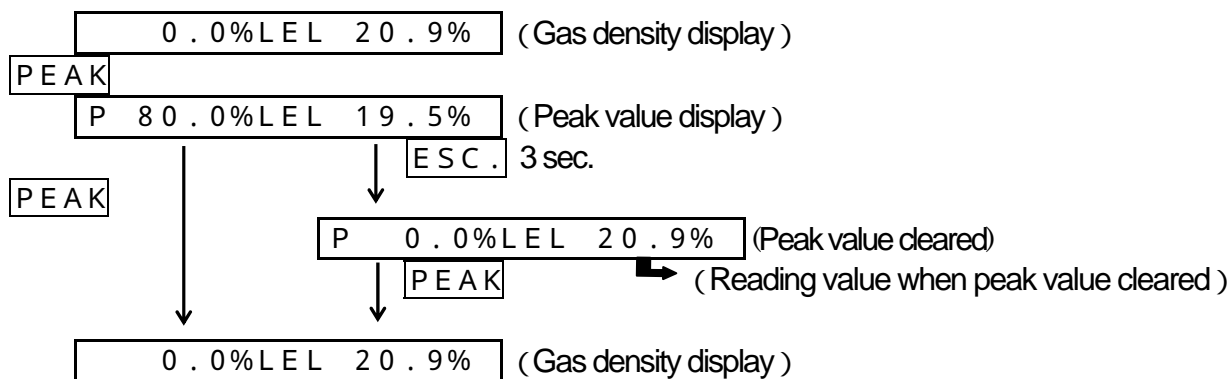

### 3 - 7 . Stop of pump operation

When transfer the sampling point or stop measurement temporarily, it can stop the running of pump only.

When stop pump running, the battery consumption can be cut by about 40% as compared with the pump running time. All except pump work and then, no warming-up time is required if re-operate the pump.

**\* Note**

- When do not measure for some time, turn off the power.  
As all except pump work, the battery will be consumed if leave the pump operation stopped.

### (1) Pump running display

< Pump running on >

This displays gas reading while in pump running.

0 . 0 % L E L 2 0 . 9 % ( Pump running )

< Pump power off >

The following message shows while in pump work stopping.

P U M P P O W E R O F F ( Pump stop operation )

### (2) Operating procedure

Pump : Running on stop

0 . 0 % L E L 2 0 . 9 % ( Pump running )

HOLD PUMP KEY	Press <span style="border: 1px solid black; padding: 0 2px;">PUMP</span> for about 3 sec.
PUMP POWER OFF	(Pump stop operation) Release <span style="border: 1px solid black; padding: 0 2px;">PUMP</span> switch after pump off.

Pump : Stop      Operation

PUMP POWER OFF	Pump power off
HOLD PUMP KEY	Press <span style="border: 1px solid black; padding: 0 2px;">PUMP</span> for about 3 sec.
PUMP POWER ON	Display for about 5 sec.      Release <span style="border: 1px solid black; padding: 0 2px;">PUMP</span> switch after pump running.
0 . 0%LEL 20 . 9%	( Pump running )

### 3 - 8 . Measurement completion

#### (1) Treatment after measurement

Roll up the sampling tube in a round bundle so that any bent or twist can not be made carefully. Make air cleaning for minimum 5 seconds until the reading comes nearby to zero point under condition that the sampling tube is connected with instrument by sucking fresh air.

#### (2) Power OFF

While pressing the power switch for about 5 seconds, the power will be off.

While pressing the power switch off, the buzzer will sound for about 15 times.

### Caution

- Do not forget to do air cleaning.

When neglect the air cleaning, the following will take place and will be a cause for trouble.

If water, oil and mist are left and condensed in dust, much of water and oil shall be sucked into instrument at the next measurement time.

As HC vapors may be absorbed completely, there will be a trouble for next time measurement.

## 4. Alarm function

### 4 - 1 . Kind of alarm and alarm function

Trouble alarm is provided for this instrument.

Each alarm is provided with buzzer, lamp and display.

#### Trouble alarm and alarm pattern

		Lamp	Buzzer	
Power ON	System error	ON	Continuous	" SYSTEM ERROR "
	Battery power shortage	ON	Continuous	"REPLACE BATTERY"
	Sensor disconnection	ON	Continuous	" FAIL SENSOR " " FAIL SENSOR HC " " FAIL SENSOR O2 "
	Pump disconnection	ON	Continuous	" FAIL PUMP "
Measurement	Low battery warning	Flicker	Intermittent	"B" flicker at left end
	Low battery alarm	ON	Continuous	"REPLACE BATTERY"
	ZERO cal. failure	OFF	No sound	" FAIL ZERO HC/ " " FAIL ZERO /O2" " FAIL ZERO HC/O2"
	SPAN failure	OFF	No sound	" FAIL SPAN HC/ " " FAIL SPAN /O2 " " FAIL SPAN HC/O2 "

#### 4 - 2 . Countermeasure at alarm

(1)System error (“SYSTEM ERROR”)

When receive an excessive noise, this error may appear.

(2)When the low battery alarm is given, replace 4 pcs of batteries with new ones according to the procedure of “5-1. Battery replacement.”

(3)Sensor connection error

When give an excessive shock or impulse to the instrument such as dropping or throwing etc. and use for a long period, such display may appear.

Carry out the daily check or regular check (See 5. Maintenance check).

(4)Pump connection error (“FAIL PUMP”)

When give an excessive shock or impulse to the instrument such as dropping or throwing etc. and use for a long period, such display may appear.

Carry out the daily check or regular check (See 5. Maintenance check).

(5)Zero cal. error (“FAIL ZERO HC/O2”)

Under the condition that zero gas (air) is not sucked correctly or water and oil etc are sucked into instrument, such display may appear. Check whether there is any damage or any sign of water or oil etc suction in the sampling tube or filter tube with the flowmonitor etc. If any error could not be found, let zero gas (air) sucked into instrument correctly and make zero adjustment (See 3-5. Zero adjustment).

(6)SPAN failure (“FAIL SPAN HC/O2”)

Under the condition that zero gas (air) is not sucked correctly or water and oil etc are sucked into instrument, such display may appear. Check whether there is any damage or any sign of water or oil etc suction in the sampling tube or filter tube with the flowmonitor etc. If any error could not be found, let calibration gas sucked into instrument correctly and make span adjustment. (See 5. Maintenance check).



## 5. Maintenance check

For this correct operation, follow the following procedure.

As this is safety instrument. Be sure to make the regular maintenance. If any trouble should take place, contact the nearest agent or Riken Keiki Co., Ltd.

### 5 - 1 . Battery replacement

#### **Warning**

- Battery replacement shall be done at non-hazardous zone by all means.
- Be sure to use the genuine batteries.

When make battery replacement, replace all 4 pcs batteries with new ones.

(1) Check that the power OFF.

When the power is ON, do it after power OFF.



(2) Remove the carrying case from the instrument.

(3) Open the battery cover by turning the screw on the bottom of instrument counterclockwise with minus screwdriver or coin etc.

(4) Remove 4 pcs batteries and put the new ones where they were by taking care of polarity.

#### **\* NOTE**

When remove battery, remove it from the polarity of (+). When put it, it is easy to replace the battery from the polarity of (-).

(5) When finish the replacement of batteries, put the battery cover in the reverse way.

#### **Warning**

- Tight up the battery cover for sure.

(6) The following battery types are the only battery types that may be used.

1. Duracell Ultra MN1400
2. Panasonic LR14 (G)
3. Toshiba LR14

## 5 - 2 . Gas calibration

The measuring range of model RX-415 is dual expanded scale of 0-100%LEL and 0-100vol% for HC, and 0-25vol% for O<sub>2</sub>. Then, the gas calibration for all ranges is required.

- (1) Prepare the calibration gas (both for low density gas and high density gas) and sampling bag.
- (2) Remove the filter tube and gas sampling tubes from the instrument. Then, arrange to connect sampling bag from the gas inlet of instrument.
- (3) Turn on the power and make zero adjustment.
- (4) Put the calibration gas<sup>\*1</sup> sampling bag and make gas calibration in the following procedure.

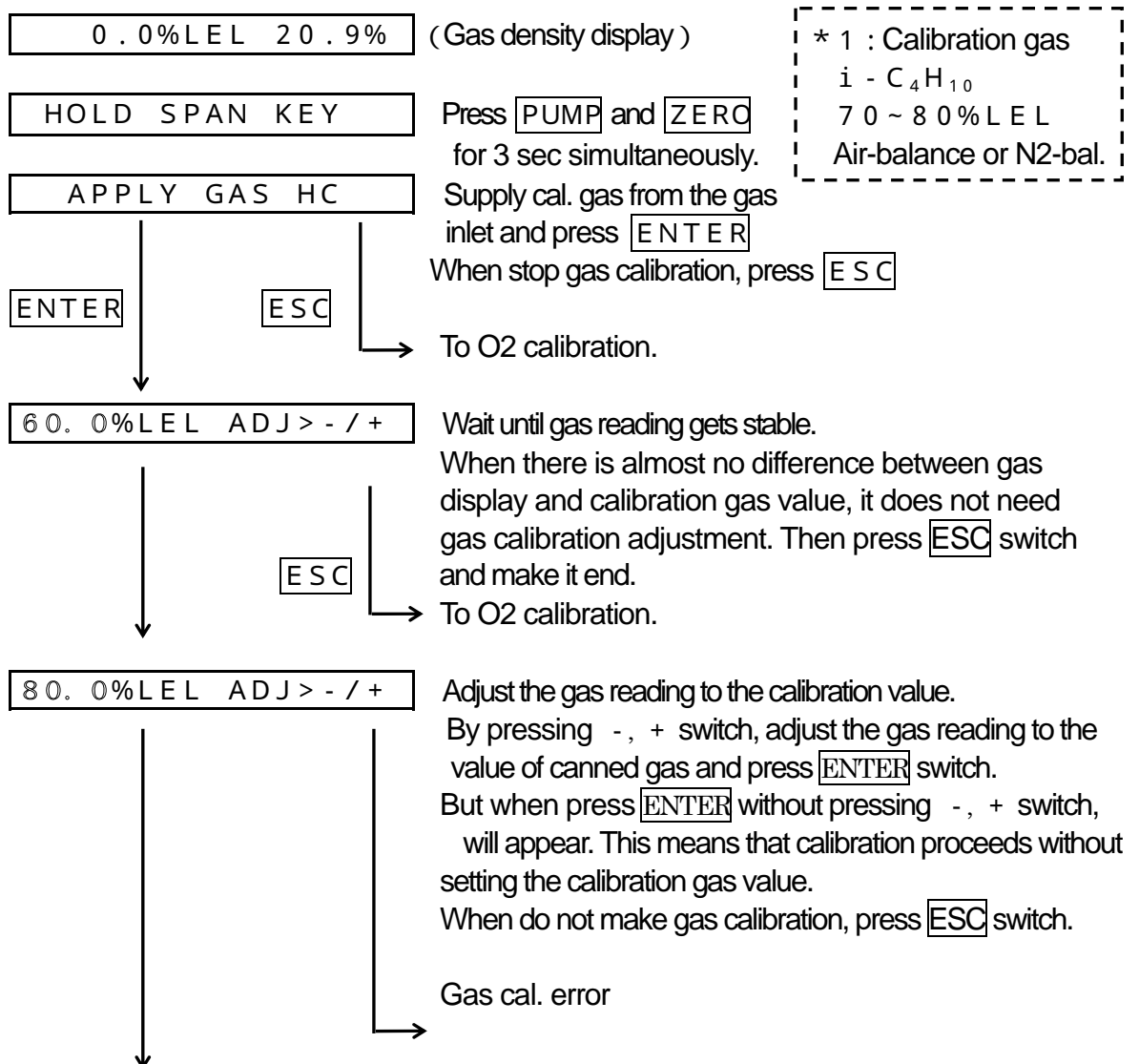

HC SPAN SET OK

Gas calibration is completed.

APPLY GAS O2

Supply calibration gas from the gas inlet.

When perform gas calibration, press **ENTER**.

When stop gas calibration, press **ESC**.

**ESC**

Completion of gas cal.



0 . 0% L E L 2 0 . 9%

( Gas density display )

Display and function in gas calibration error. (See 3)

FAIL SPAN HC /



## Danger

- Do not approach the fire at the time of gas calibration at all.  
For gas calibration, use the high density gas.

## \* Note

- Before gas calibration, confirm that the indication value is "0.0%LEL" after fresh air is sucked. Be sure to make zero adjustment when the value is not "0.0%LEL".  
End even though "0.0%LEL" is displayed, if it is flickered, zero point is deviated.  
Make zero adjustment.

(5) Put the calibration gas<sup>\*2</sup> to sampling bag and make gas calibration in the following procedure.

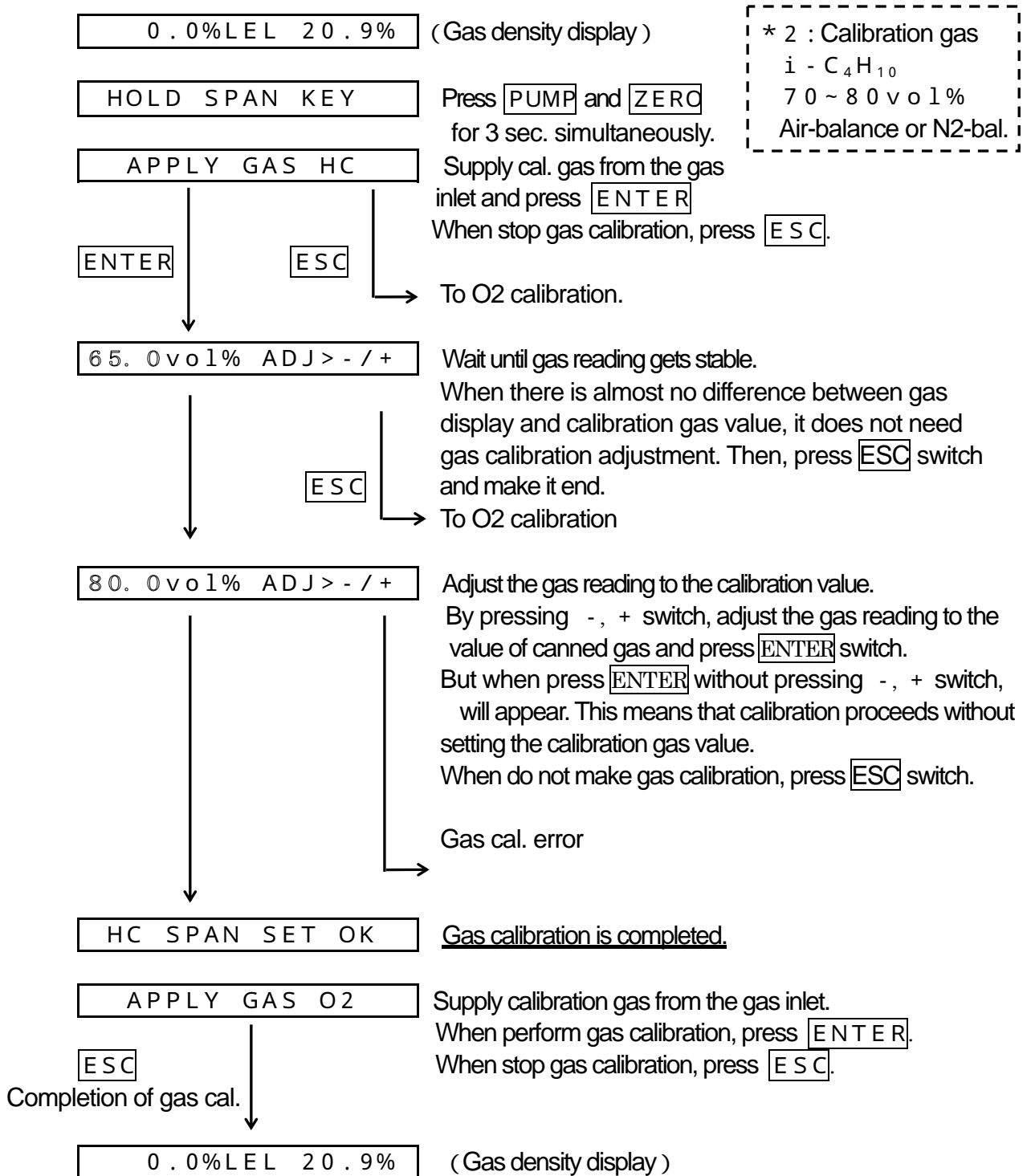

Display and function in gas calibration error.

FAIL SPAN HC/

(6) Put the calibration gas<sup>\*3</sup> to sampling bag and make gas calibration in the following procedure.

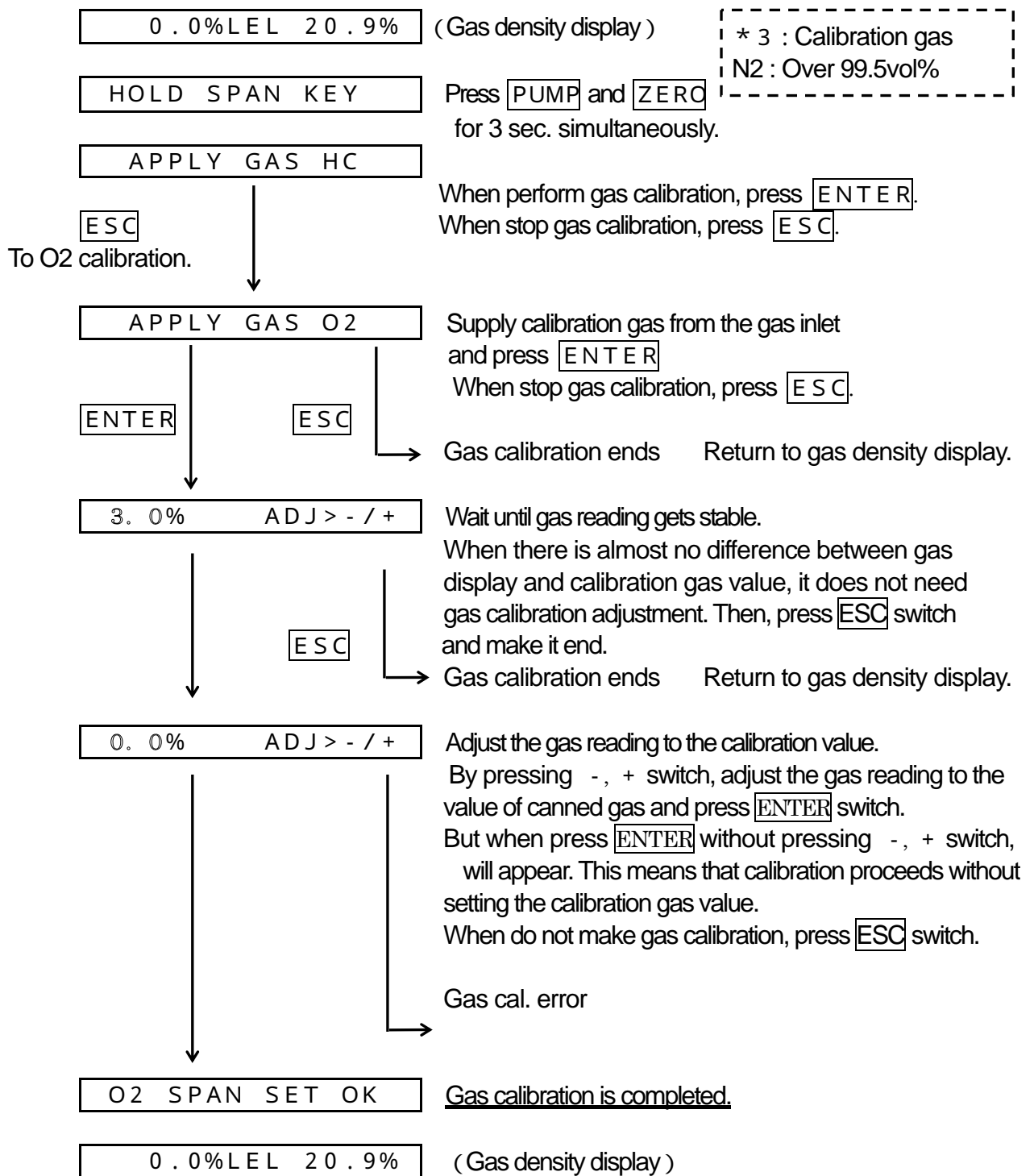

Display and function in gas calibration error.

F A I L S P A N / O 2

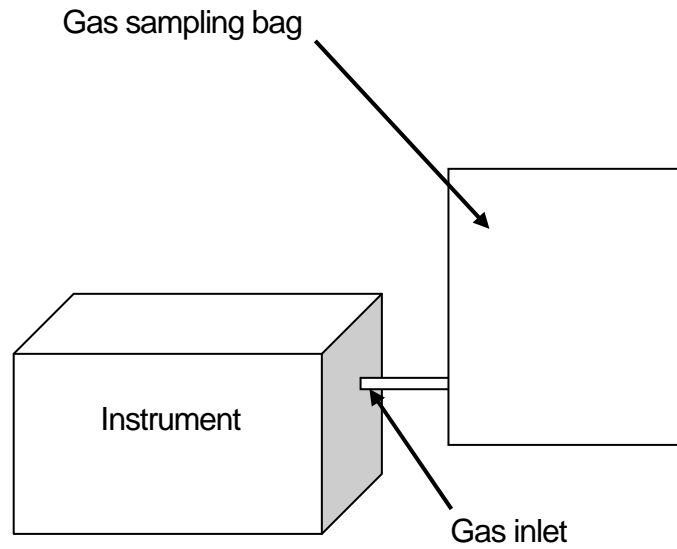

**⚠ Caution**

- Do not supply the calibration gas directly by plugging in the gas inlet from the canned gas. Because the inside of instrument may be damaged.
- Be sure to make calibration by both high density gas and low density gas. If neglect this calibration, the accurate measurement cannot be assured.

### 5 - 3 . Filter replacement

Check the filter (Cotton) in the filter tube with the flowmonitor before measurement and if it is dirty, replace it with new one.

- (1) By turning the knurling part of the filter tube with the flowmonitor, open the filter tube with the flowmonitor.
- (2) Take out the cotton filter in the filter tube with the flowmonitor by use of tweezers etc.
- (3) Put the new cotton filter so that it can be even in the filter tube with the flowmonitor and close knurling part in the reverse procedure.

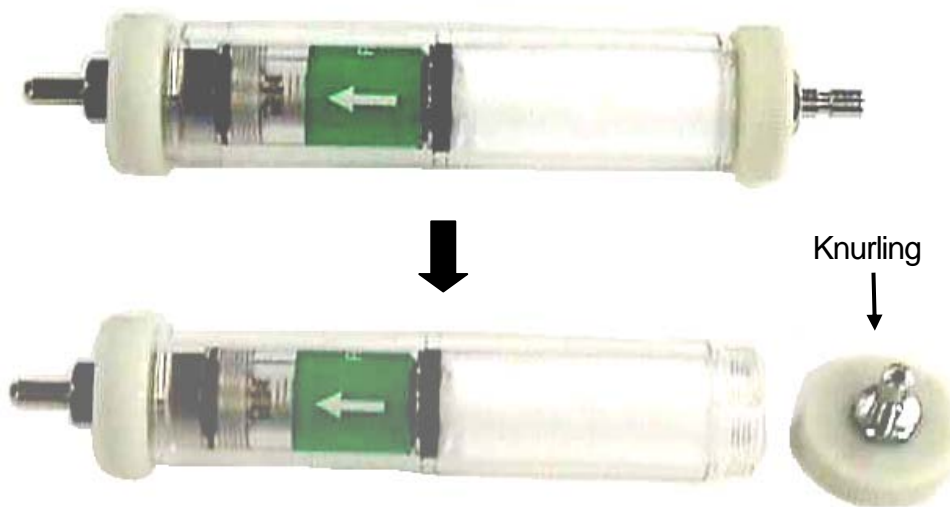

#### **⚠ Caution**

- Do not put much of cotton filter.  
If put in too much, the flow rate gets down and the accurate measurement cannot be carried out.

#### **\* Note**

- Make this filter replacement in every month.

## 5 - 4 . O2 sensor replacement

O2 sensor life of RX-415 is approx. 1 year. If the following phenomenon would be occurred, replace the sensor with new one. Sensor type is "OS-B3".

<Phenomenon >

When "Calibration error" is displayed, even though the air calibration is performed by fresh air.  
When the indication value can not be decreased even though human exhalation is introduced.  
When the indication is unstable. When it takes long time to get the stable indication.

### Caution

- Sensor life depends on utility condition and utility frequency.  
Refrain to use the instrument under the condition that there is much dust, pressure alternation, excessive high/low temperature/humidity. These condition may decrease sensor life.

### Replacement procedure

- (1)Remove the switch side cover by taking off 4 pcs of screws. (See D-1)
- (2)Pull out the connector from O2 sensor.
- (3)After removal of mounting screws and plate, O2 sensor can be taken off. (See D-2)
- (4)Take out spare O2 sensor from the case and take off copper wire from connector.  
Then, connect O2 sensor to the instrument.
- (5)Sensor shall be installed in direction as D-2 by mounting screw (2pcs) and plate.
- (6)Put the cover back and mount 4 pcs of screws. Sensor replacement is completed.



D-1

O2 sensor connector

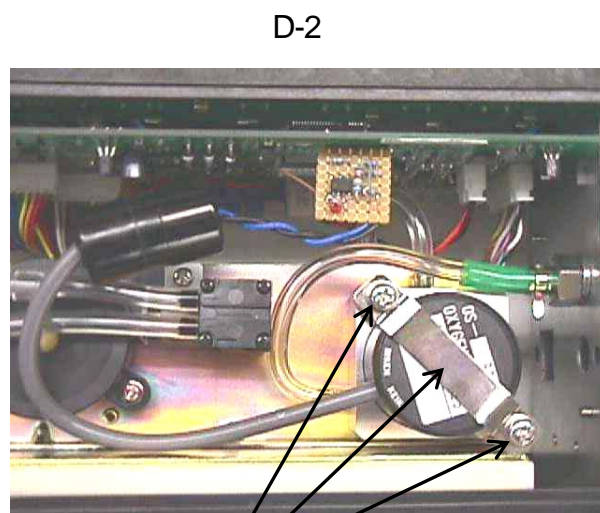

D-2

Mounting plate and screws



## 5 - 5 . Daily check and regular maintenance check

### (1)Daily check

- Are there any damage on switches, lamp, display and panel?
- Pump suction work check (Is pump suction sound normal? Can any trouble sound be heard?)
- Battery voltage check.

### (2)Regular maintenance check

We recommend calibrating the instrument at least once a year.  
The calibration can be done either on board or ashore.

## 5 - 6 . Replacement of parts

As the following parts have its own end, it must be replaced regularly.  
When replace, contact the nearest agent or Riken Keiki Co., Ltd.

Pump : Approx. 2 years (Depends on use frequency)

Internal filter : Approx. 1 year (Depends on use frequency)

Sensor : Approx. 5 years

## 5 - 7 . Storage and disposal when the instrument is not used for a long time.

Storage under following conditions

Store in a cool place avoiding direct sunlight at normal temperature & humidity  
Place where gas and solvent vapor do not exist

Storage the instrument in the box where it was

When there is no storage box, storage in vinyl and etc.

Storage the instrument indoor escaping from direct sunshine

Take off the batteries when do not use for over 1 month

## **6. Scrap of instrument**

When scrap the instrument, treat it in compliance with the local regulations of industrial waste (incombustible). For scrap of O2 sensor, contact the nearest agent or Riken Keiki Co., Ltd.

## 7. Troubleshooting

This troubleshooting does not mention the possible cause of all malfunction but simply shows it to help the cause research of probable malfunction.

Trouble	Cause	Treatment
Power can not be on	<ul style="list-style-type: none"> <li>• Empty batteries</li> <li>• Batteries are consumed up.</li> <li>• Wrong polarity of battery</li> <li>• Time shortage to press Power switch</li> </ul>	<ul style="list-style-type: none"> <li>• Put batteries in correct way by seeing the battery replacement. (See 5-1.)</li> <li>• Hold pressing for approx. 5 sec. (Until displayed)</li> </ul>
No pump running	<ul style="list-style-type: none"> <li>• No measurement and pump stops running (Display comment)</li> </ul>	<ul style="list-style-type: none"> <li>• Make re-operation of pump (See 2-6)</li> </ul>
No pump suction	<ul style="list-style-type: none"> <li>• The pipe of IN, OUT of filter or tube etc may be removed or clogged.</li> </ul>	<ul style="list-style-type: none"> <li>• Check the clog of filter pipe or twist etc and treat it correctly (See 5-3 and 2-5)</li> </ul>
Zero and span adjustment for O <sub>2</sub> is not available.	<ul style="list-style-type: none"> <li>• Is sensor life period in valid?</li> </ul>	<ul style="list-style-type: none"> <li>• The validity of sensor is expired. Replace it to new one.</li> </ul>
Zero "0.0"%LEL of gas display is flickering	<ul style="list-style-type: none"> <li>• Zero point is deviated.</li> </ul>	<ul style="list-style-type: none"> <li>• Check that there is gas free around and make zero adjust. (See 2-4)</li> </ul>
"100.0vol%" flickering	<ul style="list-style-type: none"> <li>• Zero point or gas sensitivity is deviated.</li> </ul>	<ol style="list-style-type: none"> <li>1 . Make zero adjustment. (See 2-4)</li> <li>2 . When not adjusted to reading value, make gas calibration. (See 5-2)</li> </ol>

## 8. Definition of words

### %LEL

When define the Lower Explosion Limit of combustible gas as 100%.

Methane : 100%LEL = 5.0vol%

Iso-butane : 100%LEL = 1.8vol%

### Vol%

This is the unit shown by percentage for how much a special material (or gas) in a volume is occupied in that volume.

### Combustible gas

The lower limit of Explosive Limit (Explosive limit when mixed with air) is to be below 10%.  
The difference between upper and lower limits is to be above 20%.

### HC gas

General name of hydrocarbon.

### in Air

The atmosphere of  $-10 \sim +40^{\circ}\text{C}$ , below 90%RH in an atmospheric pressure (0113hPa)

### Hang-up phenomenon

This is the phenomenon to show slightly higher reading than the actual one by the influence residual gas for some while though fresh air is supplied after high density gas was sucked into instrument.

### Oxygen deficiency

Phenomenon that may cause human health disorder.

## 9. Specifications

### 9 - 1 . Specifications

MODEL : RX - 4 1 5 ( TYPE HC )

Detection principle	Galvanic cell	NDIR (Non-Dispersive Infrared method)
Detection gas	Oxygen (O <sub>2</sub> )	HC
Calibration gas	Oxygen	Iso-butane
Measurable range	0-25vol% (0.1vol%)	0-100%LEL / 0-100vol% [Dual auto range] (0.5%LEL) / (0.5vol%)
Increment	Within $\pm 0.7$ vol%	$\pm 5\%$ of full scale (0-100%LEL) $\pm 5\%$ of full scale (0-100vol%) or $\pm 10\%$ of reading (0-100vol%) (Under same condition)
Response time	Within 20 sec. (T <sub>90</sub> , When sucked from gas inlet)	Within 30 sec. (T <sub>90</sub> , When sucked from gas inlet) Within 2 min. (T <sub>90</sub> , When sucked from end of 30m tube)
Sampling	Suction pump	
Suction rate	Over 300ml / min.	
Ambient temp/ Humidity	-10 ~ 40 / below 90%RH (Non-condensing)	
Power source	Alkaline batteries (Size C) 4 pcs	
Continuous operation time	Approx. 40 hours (No alarm / No light at 20 )	
Explosion proof	EExdia BT3	
Dimension/ weight	Approx. 200(W) x 80(H) x 142(D)mm / Approx. 2.0kg (Batt. included)	

**MODEL : RX - 4 1 5 ( TYPE CH<sub>4</sub> )**

Detection principle	Galvanic cell	NDIR (Non-Dispersive Infrared method)
Detection gas	Oxygen (O <sub>2</sub> )	CH <sub>4</sub>
Calibration gas	Oxygen	Methane
Measurable range	0-25vol% (0.1vol%)	0-100%LEL / 0-100vol% [Dual auto range] (0.5%LEL) / (0.5vol%)
Increment	Within ± 0.7%	± 5% of full scale (0-100%LEL) ± 5% of full scale (0-100vol%) or ± 10% of reading (0-100vol%) (Under same condition)
Response time	Within 20 sec. (T <sub>90</sub> , When sucked from gas inlet)	Within 30 sec. (T <sub>90</sub> , When sucked from gas inlet) Within 2 min. (T <sub>90</sub> , When sucked from end of 30m tube)
Sampling	Suction pump	
Suction rate	Over 300ml / min.	
Ambient temp/ Humidity	-10 ~ 40 / below 90%RH (Non-condensing)	
Power source	Alkaline batteries (size C) 4 pcs	
Continuous operation time	Approx. 40 hours (No alarm / No light at 20 )	
Explosion proof	EExdia BT3	
Dimension/ weight	Approx. 200(W) x 80(H) x 142(D)mm / Approx. 2.0kg (Batt. included)	

9 - 2 . Accessories (Common for HC and CH4)  
Ordering Information

(1) Standard accessories		
Description	Parts number	
Alkaline batteries (Size C) 4pcs	2753200490	
Filter tube with the flowmonitor and connection line with coupling 1pce	4126918220	
Junction tube 1pce	0914013070	
Spiral sampling tube (1m) 1pce	0914007240	
Gas sampling probe 1pce	0904017880	
Carrying case with shoulder strap 1pce	4775957210	
Operation manual		
Test report		
(2) Optional accessories		
Description	Parts number	
Sampling bag 1 litter (Green) (Orange)	0904010380 0904010450	
Absorbent cotton	1879001110	
Metal storage box	4000272690	
Gas sampling tube 30m Black (with stick probe or float probe) Gas sampling tube 20m Black (with stick probe or float probe) Gas sampling tube 10m Black (with stick probe or float probe) Gas sampling tube 29m Orange + Junction tube 1m Orange (with stick probe or float probe)		

## 10. Detection principle

### 10 - 1 . NDIR method (Non-Dispersive Infrared)

Model RX-415 is based on NDIR method (Non-Dispersive Infrared) and this structure is shown below.

The infrared beam emitted from the light source passes through the measuring cell, and optical band pass filter which can pass the absorption wave of measuring gas and attains to the infrared sensor. The amount of infrared attaining to the infrared sensor through the measuring cell and will decrease according to its density.

The variable amount of infrared is measured by the infrared sensor and it is displayed as gas concentration.

Then, there is no sensitivity against CO<sub>2</sub> and CO etc which have the different absorption wave from the measuring gas. Then there is no sensitivity against N<sub>2</sub> and H<sub>2</sub> etc which cannot absorb infrared. As compared with the conventional catalytic combustion method, there is no poisoning material to be absorbed and almost no sensitivity drop on this detection principle.

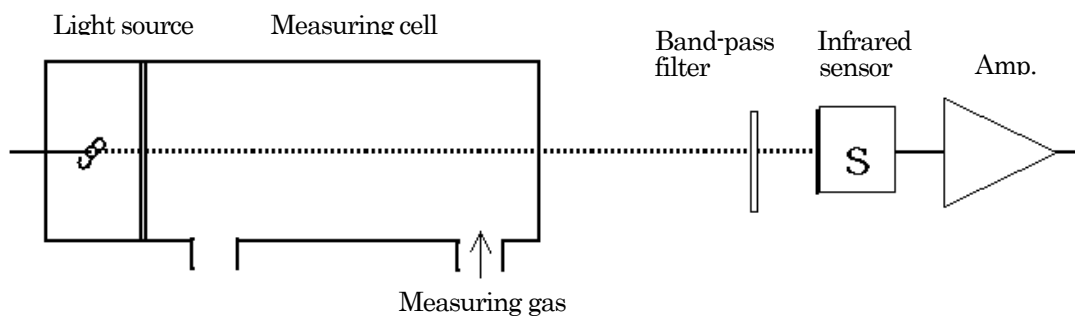

### 10 - 2 . GALVANIC CELL method

Galvanic cell consists of a lead anode and a gold cathode in electrolyte covered by a membrane. When oxygen enters into the gold cathode, a current which is directly proportional to the oxygen concentration will be produced, and amplified current will produce a reading on a meter in percent oxygen.

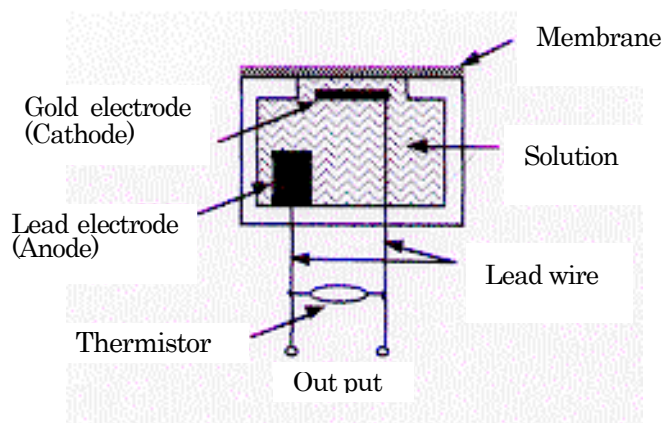



# RIKEN KEIKI STANDARD WARRANTY

## GAS DETECTION INSTRUMENTS

RIKEN KEIKI CO., LTD. warrants gas alarm equipment manufactured and sold by us to be free from defects in materials and workmanship for a period of one year from date of shipment from RIKEN KEIKI CO., LTD. Any parts found defective within that period will be repaired or replaced, at our option, free of charge, F.O.B. Factory. This warranty does not apply to those items which by their nature are subject to deterioration or consumption in normal service, and which must be cleaned, repaired or replaced on a routine basis. Such items may include:

- a) Lamp bulbs and fuses
- b) Pump diaphragms and valves
- c) Absorbent cartridges
- d) Filter elements
- e) Batteries

Warranty is voided by abuse including rough handling, mechanical damage, operation, alteration or repair procedures not in accordance with instruction manual. This warranty indicates the full extent of our liability, and we are not responsible for removal or replacement costs, local repair costs, transportation costs, or contingent expenses incurred without our prior approval.

THIS WARRANTY IS EXPRESSLY IN LIEU OF ANY AND ALL OTHER WARRANTIES AND REPRESENTATIONS, EXPRESSED OR IMPLIED, AND ALL OTHER OBLIGATIONS OR LIABILITIES ON THE PART OF RIKEN KEIKI CO., LTD. INCLUDING BUT NOT LIMITED TO, THE WARRANTY OF MERCHANTABILITY OR FITNESS FOR A PARTICULAR PURPOSE. IN NO EVENT SHALL RIKEN KEIKI CO., LTD. BE LIABLE FOR INDIRECT, INCIDENTAL OR CONSEQUENTIAL LOSS OR DAMAGE OF ANY KIND CONNECTED WITH THE USE OF ITS PRODUCTS OR FAILURE OF ITS PRODUCT TO FUNCTION OR OPERATE PROPERLY.

This warranty covers instruments and parts sold (to users) only by authorized distributors, dealers and representatives as appointed by RIKEN KEIKI CO., LTD.

We do not assume the indemnification for any accident or damage caused by the operation of this gas monitor and our warranty is limited to the replacement of parts or our complete goods.